

(4)

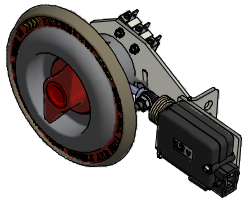

NAME : EMERGENCY EXIT WITH MOTOR  
NO : 70 150 3601  
QUANTITY : 1

(5)



NAME : EMERGENCY EXIT HANDLE  
NO : 70 150 5004  
QUANTITY : 1

(6)



NAME : THE WIRE 3200mm  
NO : 10 009 0103  
QUANTITY : 2

(7)

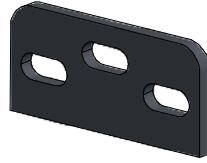

NAME : EXTENSION PART  
NO : 10 026 1876  
QUANTITY : 1

(8)

62mm



NAME : DOOR CONNECTION SET (62mm)  
NO : 30 001 0144  
QUANTITY : 1

(9)

72mm

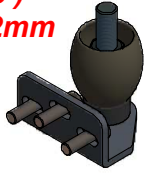

NAME : DOOR CONNECTION SET (72mm)  
NO : 30 001 0145  
QUANTITY : 1

(10)

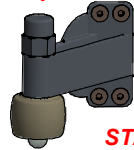

STANDARD

NAME : UPPER CONNECTION SET  
NO : 30 001 0037  
QUANTITY : 1

(11)



ANLAŞ 283

NAME : DOOR CONTROL UNIT (ANLAŞ 283)  
NO : 10 024 0283  
QUANTITY : 1

(12)



NAME : MECHANISM COVER  
NO : 10 011 0132  
QUANTITY : 1

(13)

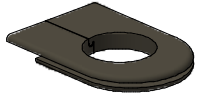

NAME : COVER RUBBER  
NO : 10 011 0113  
QUANTITY : 1

(14)



MODEL 12

NAME : CABLE SET MODEL 12  
NO : 10 009 1001  
QUANTITY : 1

(15)

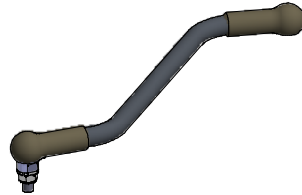

NAME : POS 10A BALANCE HANDLE  
NO : 30 001 0370  
QUANTITY : 1

(16)

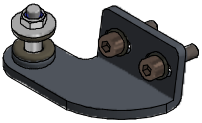

NAME : BALANCE HANDLE CONNECTION SET  
NO : 30 001 0826  
QUANTITY : 1

(17)

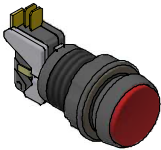

NAME : BUTTON  
NO : 10 024 0132  
QUANTITY : 1

(18)

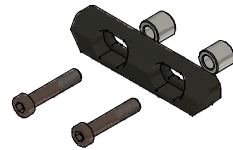

NAME : LOCK SET  
NO : 30 001 0820  
QUANTITY : 4

(19)



NAME : LOCK SET  
NO : 30 001 0821  
QUANTITY : 4

(20)



NAME : VALVE COVER  
NO : 40 070 3000  
QUANTITY : 1

## DEĞİŞİKLİK

DEĞ.NO. TARİH YAPAN AÇIKLAMA

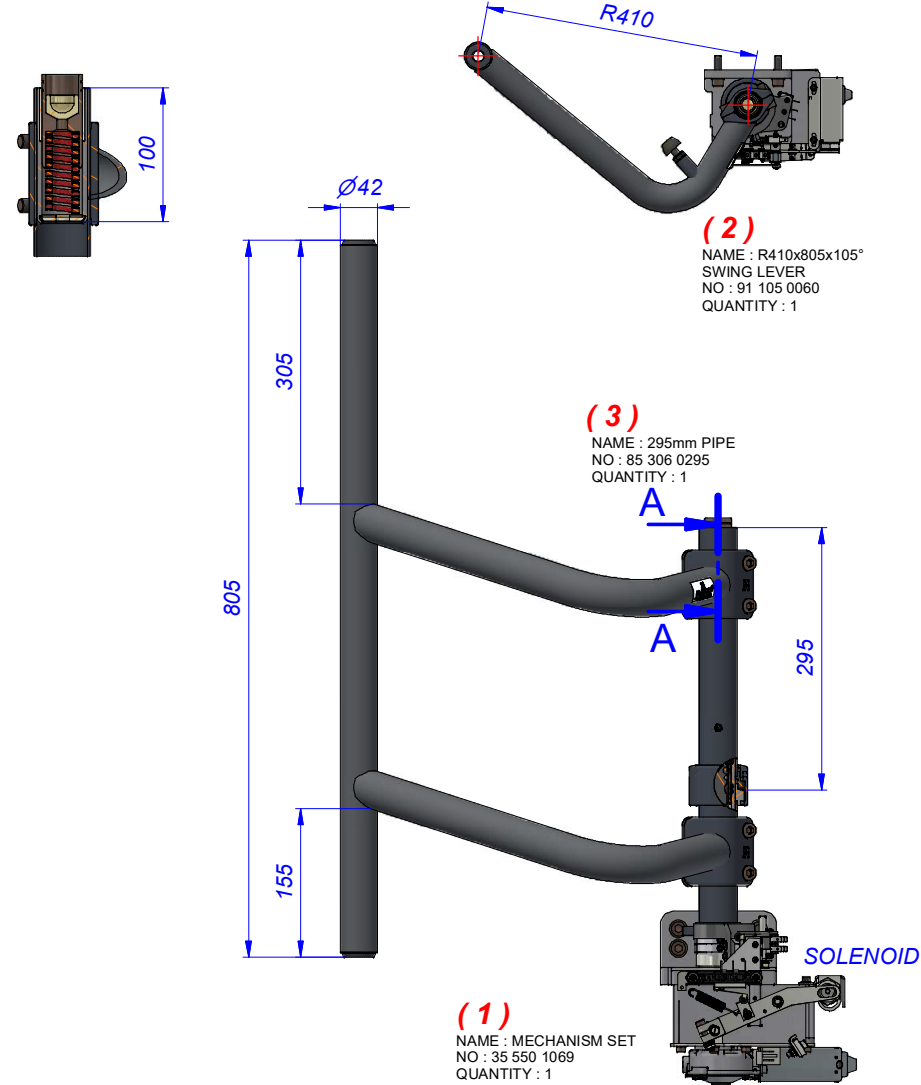

AD SOYAD NAME SURNAME	TARİH DATE	İMZA SIGNATURE		
ÇİZEN DESIGNER	Senem ÇALIŞKAN	11.03.2024		
KONTROL TO CHECK	Murat YAKIN	11.03.2024		
ONAY TO APPROVE	Murat YAKIN	11.03.2024		
PARÇA ADI MATERIAL NAME	MECHANISM SET ŞFB			OTOBÜS MINİBÜS KAPI SİSTEMLERİ BUS & MINIBUS DOOR SYSTEMS
PARÇA NO MATERIAL NO	35 060 0513			
HAMMADDE MATERIAL NO	xxx	HAMMADDE MATERIAL NO	xxx	KRİTİK ÖLÇÜ CRITICAL DIM. KAPLAMA & BOYA COVER & COLOR
REVİZYON REVISION	0	EBAT SIZE	A3	ÖLÇEK SCALE
			1/6	KAPLAMA & BOYA COVER & COLOR

ŞFB AUTOMOTIVE